

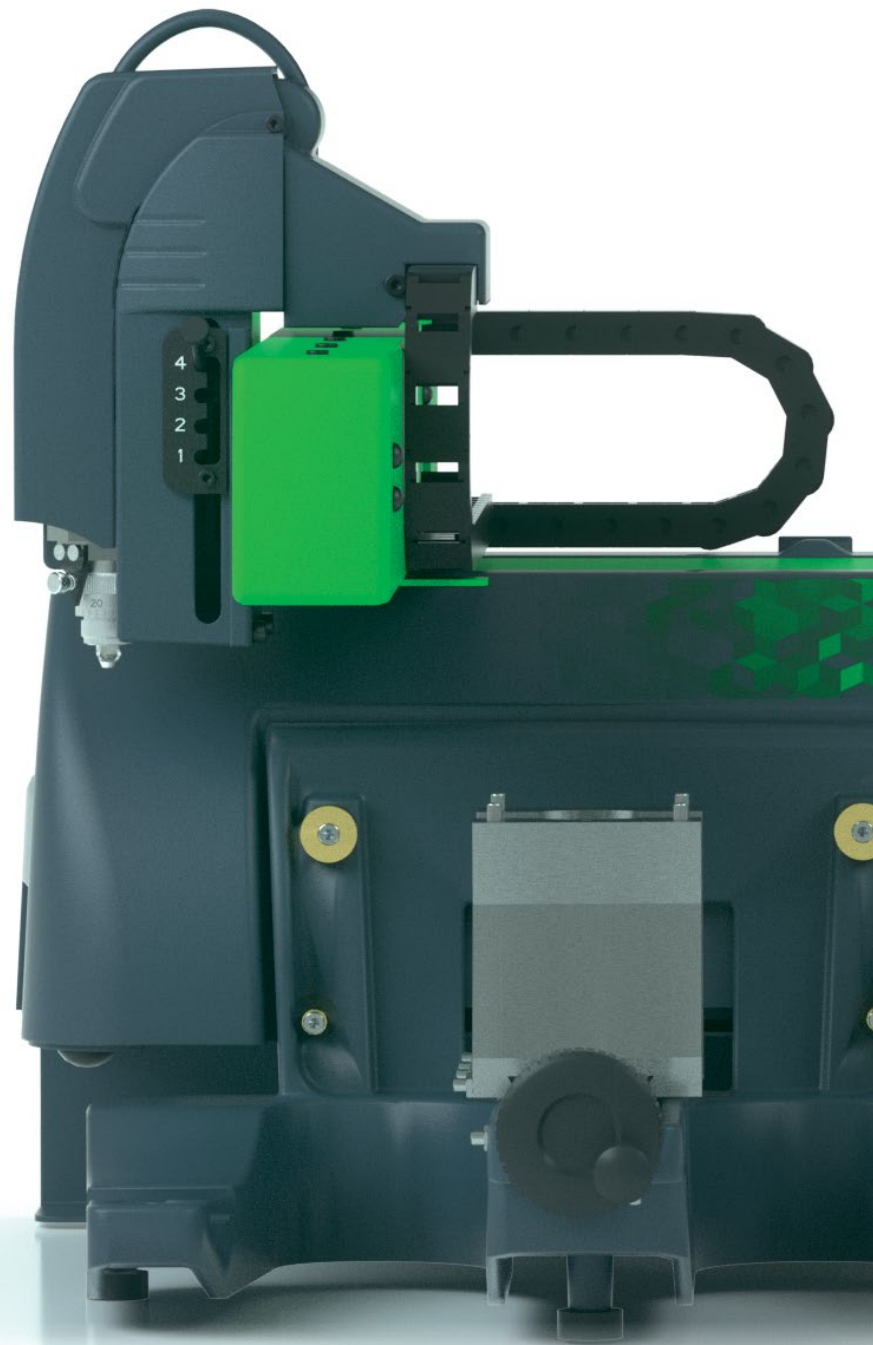

ENGRAVING STATION

**M40 / M40 GIFT**



**GRAVOTECH**  
EXPRESSION OF THINGS



The M40 is a compact versatile signage engraving machine. Its large engraving area makes it a perfect engraving solution for medium-sized and flat objects. It can engrave a large range of materials such as plastic, glass, wood, metal, and many more!

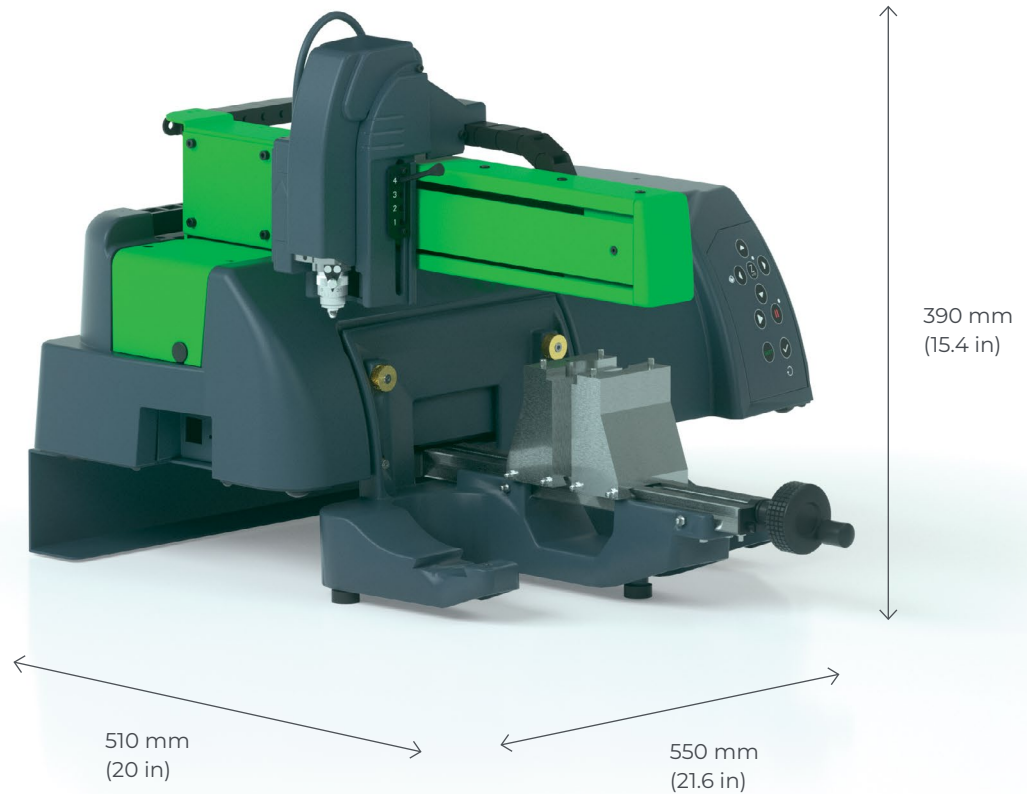

### **OPEN STRUCTURE**

Don't let your machine decide what you can or can't engrave. The M40 210 x 305 mm (8.3 x 12 in) engraving area benefits from an open structure that allows larger items to be engraved when needed. Engrave very long plastic signage plates, electrical labels, thin wood beams, golf clubs, swords, irregular-shape items, and more.

### **ENGRAVE GLASS WITH THE M40 GIFT VERSION**

The M40 Gift includes an automatic lubricant tank and a rotary device to personalize glasses and bottles. The rotary device can be tilted for conical items. Engrave and personalize any flat or cylindrical items up to 110mm height.

### **ADAPTED FOR BEGINNERS**

Control and adjust your work with our dedicated Gravostyle™ or ABC engraving software thanks to several options. The M40 comes with an auto-centering jig and a laser beam (Point & Shoot) to help you place the item to engrave, while the engraving software automatically picks up its position. The included Gravogrip™ table firmly holds the item without leftover residue on it.

SEE OUR VIDEO



## KEY FEATURES



### Professional Signage

The M40 engraving area matches the professional plate standards (doctor, lawyer, notary plates). It is the perfect plate engraving machine to engrave small and medium-sized plates and signs.

Create in-house technical identification plates, electrical labels, operating instructions for appliances, professional plaques and many more.

The engraving software mirror mode allows engraving on the reverse side of acrylic plates, for a clear and professional finish.

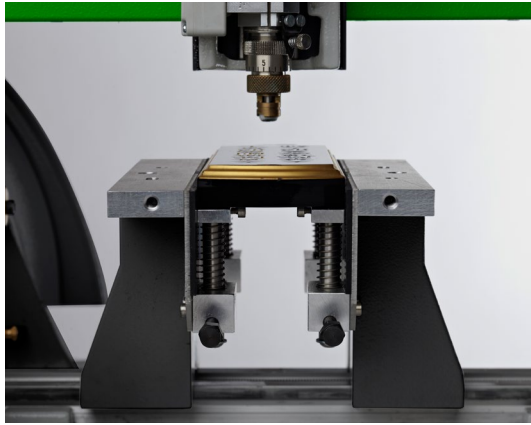

### Funeral Market

Create all kinds of funeral signage with your M40 engraving machine.

Engrave wood, plastic, metal, coffin plates, or urns thanks to a cylindrical attachment, personalize commemorative items, add text, figures, and symbols to your composition and more.

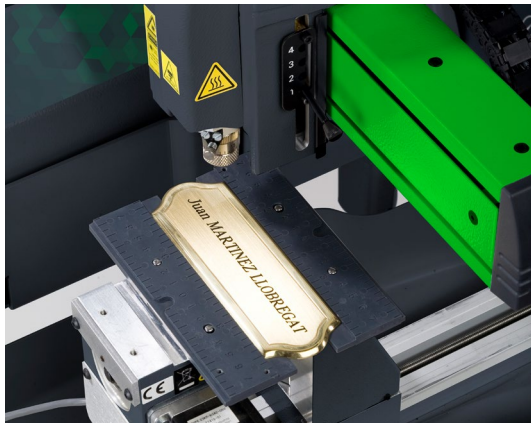

### Colored Engraving

Add color to your creation after the engraving. Apply black Gravolaque on plaques for a contrasted result, or personalize your plastic signs with cold wax (several colors available).

Gravotech offers a wide choice of two-layer materials: take off the first layer to see the second one, and get colorful signs without adding any chemical product. Check our consumables catalog to see all the color combinations. Compatible with interior and exterior usage.

LEARN MORE ABOUT THE M40



# SOFTWARE

NOVICE

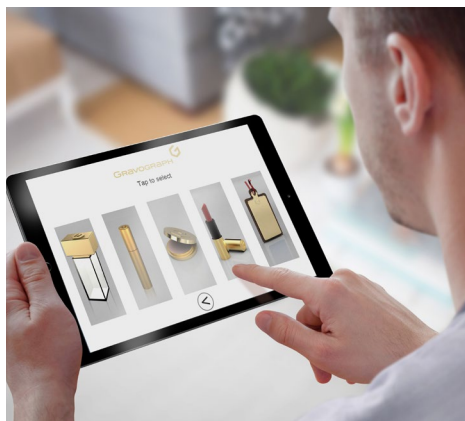

## ABC Catalog

Do you have a limited range of products to engrave? ABC Catalog is the right choice for you!

Contact us for a customized Catalog version, integrating your own range of products.

BEGINNER



## ABC

ABC software is the easiest engraving software for Gravotech laser and rotary machines. Engrave in only 3 simple steps, from a computer or a tablet!

EXPERT

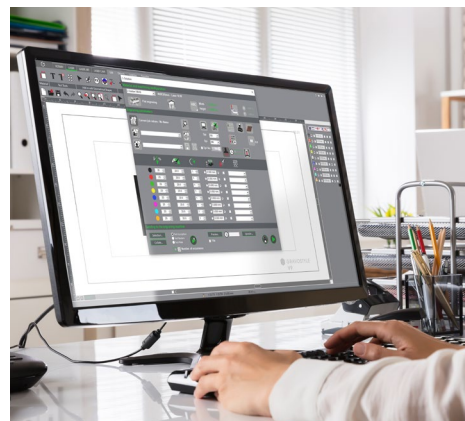

## Gravostyle™

One-of-a-kind piloting software for Gravotech laser and rotary engraving machines.

# SERVICE & SUPPORT



## Training

Our training modules are designed to optimize your use of our solutions and are available for our full range of machines, software and accessories.

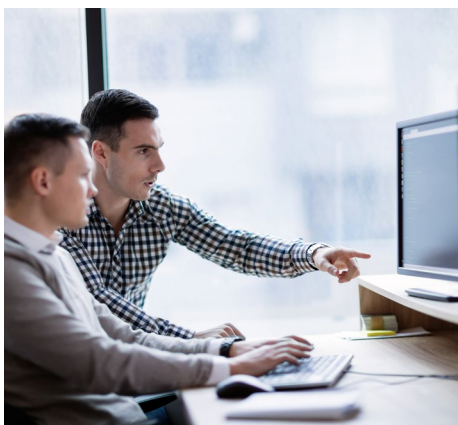

## Technical support

We bring you local support in your language in more than 50 countries, where we have established presence directly and with our distribution partners.



## Maintenance

Thanks to experience gathered with Gravograph and Technifor and our global presence in more than 50 countries with 150 Gravotech technicians and our distributor partners, we can offer you a wide range of services.



# APPLICATIONS



Funeral plaques and headstones engraving



ID Tags



Marking tools for identification and equipment traceability



Express Engraver



Gift Engraving

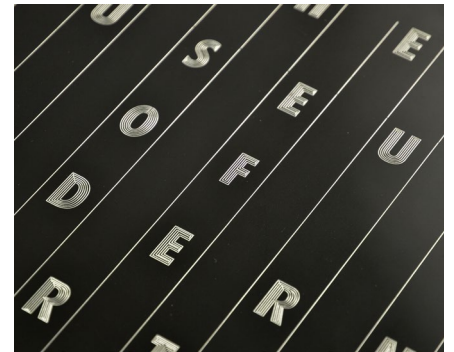

POP displays and sign engraving

# MATERIAL CHARACTERISTICS

Technology		ROTARY	DIAMOND DRAGGING
Materials	Glass, Crystal	●	
	Leather	◄○	
	Wood, varnished wood	◄○	
	Plastics	◄○	
	Anodized aluminum	◄○	●
	Brass	◄○	●
	Gold, silver, nickel, platinum	◄○	●
	Metals	○	●

◄ = Cutting    ○ = Engraving / Deep marking    ● = Marking / Etching

MAKE YOUR SAMPLES



# TECHNICAL DATA

	M40	M40 GIFT
<b>Technology</b>	Rotary, scribing	
<b>Marking area max</b>	305 x 210 mm (12 x 8.3 in)	
<b>Max objects size (L x W x H)</b>	Unlimited x 210 x 110 mm (unlimited x 8,3 x 4.3 in)	Unlimited x 210 x 160 mm (unlimited x 8,3 x 6.3 in)
<b>Max objects weight</b>	10 kg (22 lbs)	5 kg (11 lbs)
<b>Spindle power</b>	30 W	
<b>Machine dimensions (L x W x H)</b>	550 x 510 x 390 mm (21.6 x 20 x 15.4 in)	750 x 540 x 570 mm (29.5 x 21.3 x 22.4 in)
<b>Machine weight</b>	19 kg (41.9 lbs)	35 kg (77.2 lbs)
<b>Z axis auto</b>	Yes	Yes
<b>Type of spindle</b>	Top load spindle - Hollow shaft motor	
<b>Noise</b>	< 70 dB	
<b>Point &amp; shoot</b>	Yes	
<b>Operating temperature</b>	min. +5°C (+ 41°F) - max. +40°C (+104 °F)	
<b>Connection to computer</b>	USB / Bluetooth (option)	
<b>Maximum speed</b>	25 mm/s (0,98 in/s)	
<b>Z stroke (Z travel)</b>	40 mm (1,575 in)	
<b>Rotation speed</b>	20 000 rpm	
<b>Tool diameter</b>	4,36mm (0,17 in)	



[info.in@gravotech.com](mailto:info.in@gravotech.com)

+91 20 41 03 00 01

[www.gravotech.in](http://www.gravotech.in)

**GRAVOTECH ENGINEERING PVT LTD**

Gat No 2323/1, 'Reality Warehousing', Nagar Road  
412207, Pune – Wagholi, India

Follow us:

